

McIntosh

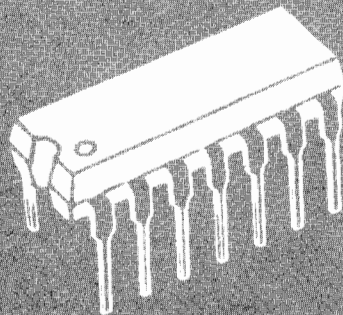
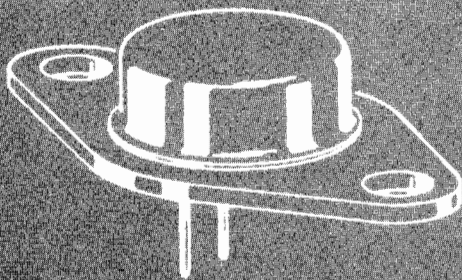
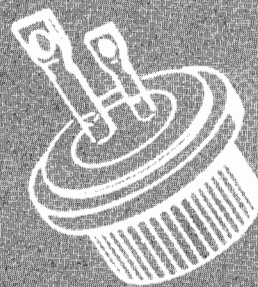

SEMICONDUCTOR DATA

NOVEMBER 1975

McINTOSH LABORATORY INC. 2 CHAMBERS STREET BINGHAMTON, NEW YORK

SEMICONDUCTOR
DATA

This manual contains information covering semiconductor devices used in McIntosh products. The manual is divided into three sections.

REPLACEMENT AND IDENTIFICATION SECTION

This section lists all devices and tells if the part is "current" or "obsolete". If the part is current, it is available from Customer Service. If the part is obsolete a replacement part is indicated. A first choice replacement is indicated, and in some cases a second choice. Also a commercial type number is given. The commercial type may or may not be identical with the original part but is a satisfactory replacement should this McIntosh part not be available. A few parts are indicated as "repair"; these parts are obsolete but are still available for repair purposes.

Furthermore this section lists physical identifying marks of each device.

Letters shown in parenthesis on the chart mean:

- (a) the replacement part has a different lead arrangement than the original. Refer to the outline drawing for the replacement part.
- (b) the replacement part has a different case type and may require a mounting arrangement.
- (c) the replacement commercial type shown may be used to replace the McIntosh part but it is not identical.

TEST DATA SECTION

This section lists basic electrical specifications for each device.

This information may be used to test the device or help select an emergency substitute.

OUTLINES SECTION

This section shows the semiconductor physical size and lead arrangement.

All drawings pertaining to transistors and integrated circuits are views from the bottom of the device; one exception is the dual-in-line package of some integrated circuit devices. Here the view is from the top.

DIODE REPLACEMENT AND IDENTIFICATION DATA

PART NO.	STATUS	1st CHOICE	2nd CHOICE	COMMERCIAL TYPE	OUTLINE DWG.	MARKING	COLOR CODE
070-001	Obs.	070-020			20		Red/Grn/ Yel
070-002	Obs.	070-035		1N754A	20		
070-003	Cur.			1N541/1N542	20	003	Blk
070-004	Obs.	Use 4 ea. 070-031			34A		
070-005	Obs.	070-031		GE#20PH6RED1	35	20PH6RG	
070-006	Obs.	070-032			21	597M-27	
070-007	Obs.	070-032		1N2863	21	1N2863	
070-008	Obs.	070-031		1N1217	21	1N1217	
070-009	Obs.	070-031		1N647	20	1N647	
070-010	Obs.	070-031		1N3756	21	1N3756	
070-011	Obs.	070-024		1N758A	20	1N758A	
070-012	Obs.	070-025		1N982B	20	1N982	
070-013	Obs.	Use 2 ea. 070-031			34B	SR132A114	
070-014	Obs.	070-031			25	A13AX9	
070-015	Obs.	070-031			25	A13DX8	
070-016	Obs.	070-032			25	A13MX8	
070-017	Obs.	070-033			25	A13NX8	
070-018	Repair			EDAL-G6R19H	36	G6R19H	
070-019	Obs.	Use 2 ea. 070-031			28		
070-020	Repair			NUCLEONIC V13	20	020	Brn
070-021	Obs.			1N4744	26	1N4744	
070-022	Obs.	070-047		1N914A	20	022	Blu
070-023	Obs.	070-035		1N754A	20	023	Red
070-024	Cur.			1N758A	20	024	Orn
070-025	Cur.			1N982B	20	025	Yel
070-026	Repair			EDAL-G4R48H	37	G4R48H	
070-027	Obs.	070-041		1N4720	21	1N4720	
070-028	Obs.	070-031		1N4001	26		
070-029	Obs.			1N3799	27	1N3799	
070-030	Obs.	070-031		1N4816	24	030 or 1N4816	Brn
070-031	Cur.			1N4820	24	031 or 1N4820	Red
070-032	Cur.			1N4822	24	032 or 1N4822	Orn.
070-033	Obs.	070-043		1N5053	24	033 or 1N5053	Yel
070-035	Repair			Fairchild F2901	6B	FZ901	
070-036	Obs.	070-043		Westinghouse 398P	24	398P	
070-037	Obs.	070-053		1N3050B	24	1N3050B	

REPLACEMENT

DIODE REPLACEMENT AND IDENTIFICATION DATA

REPLACEMENT

PART NO.	STATUS	1st CHOICE	2nd CHOICE	COMMERCIAL TYPE	OUTLINE DWG.	MARKING	COLOR CODE
070-038	Cur.			1N3492R	22	1N3492R	
070-039	Cur.			1N3492	22	1N3492	
070-040	Obs.	070-046		GE STB 581	23	STB581	
070-041	Cur.			Westinghouse 398B	24	041 or 398B	Grn
070-042	Obs.	070-048		1N966A	20	042 or 1N966A	Grn
070-043	Repair			1N4724	21	1N4724	
070-044	Cur.			EDI-PD40	30	PD40	
070-045	Obs.	070-051		EDI-PD05	30	PD05	
070-046	Cur.			MOT./MZ2361	29	046	
070-047	Cur.		070-022	1N4148	23	047 or 1N4148	Blu
070-048	Cur.			1N966B	20	048 or 1N966B or BZY88/C16	Wht
070-049	Cur.			MOTO./1N4749A	26	049 or 1N4749A	
070-050	Cur.			MOTO./MDA990-2	39	050 or MDA990-2	
070-051	Cur.			EDI-PE05	30		
070-052	Cur.		070-003 ($V_f < .5V$ @2mA)		20	003	Blk/Grn
070-053	Repair			Power Components 3TZ180B	24		
070-054	Cur.			Mullard BZX61-C51	20		
070-055	Cur.			MOTO./MPN3401	41		Blu/Brn
070-056	Cur.			T.I. TIL209	43		
070-057	Cur.			AMPX./1N750A	20		
070-058	Cur.			MOTO./MR992A	42		
070-059	Cur.			MOTO./1N4006	26		
070-060	Cur.			Semicon ZB200B			
070-061	Cur.			AMPX./BZX61 C15	20		
070-062	Cur.			MOTO./1N987B	20	062 or 1N987B	Grn
070-063	Cur.			MOTO./1N4751A	26		
070-064	Cur.			MOTO./1N968A	20		
070-065	Cur.			Mullard BZX61-C24	20	065	
070-066	Cur.			AMPX./BZX61 C9V1	26	BZX61	
070-067	Cur.			1S351	20	JRC16361	
070-068	Cur.			1S188	20		
070-069	Cur.			1N34A	20		
070-070	Cur.			1S2473	20		

DIODE REPLACEMENT AND IDENTIFICATION DATA

PART NO.	STATUS	1st CHOICE	2nd CHOICE	COMMERCIAL TYPE	OUTLINE DWG.	MARKING	COLOR CODE
070-071	Cur.			V06C	25		
070-072	Cur.			V05C	25		
070-073	Cur.						
070-074	Cur.			WZ162	20		
070-075	Cur.			1N755	42		
070-076	Cur.			SOL./J775-2			
070-077	Cur.			SAR./2VR15A			
070-078	Cur.			AMPX./BZX-61/ C12	26		
070-079	Cur.						
070-080	Cur.			MOT/MV209	48B		
070-081	Cur.			HP5082-2800	20		
070-082	Cur.			MOT/1N975- 1N5259	42		
070-083	Cur.			JAP/30600420	42		
070-084	Cur.			MOT/MV209	48B		
070-085	Cur.			MOT/1N5234B	42		
070-086	Cur.			HP/5082-3188	42		
070-087	Cur.			MOT/MR250-2	26	087 or MR250-2	
070-088	Cur.			MOT	59		
070-089				SPR/1N5862B	48A	089 or 1N5862	

REPLACEMENT

THYRISTOR & TRIGGER REPLACEMENT & IDENTIFICATION DATA

PART NO.	STATUS	1st CHOICE	2nd CHOICE	COMMERCIAL TYPE	OUTLINE DWG.	MARKING	COLOR CODE
131-001	Cur.			G.E./SC41F	18	SC41F	
131-002	Obs.	131-004		2N4992	3B	2N4992	
131-003	Obs.			MOTO./MAC-6-2	19	003 or MAC6-2	
131-004	Cur.			G.E./4991	3B	2N4991	
131-005	Cur.			MOTO./MAC11-2	40	005 or MAC11-2	
131-006	Obs.						
131-007	Obs.			2N5064	49J		

REPLACEMENT

TRANSISTOR REPLACEMENT & IDENTIFICATION DATA

PART NO.	STATUS	1st CHOICE	2nd CHOICE	COMMERCIAL TYPE	OUTLINE DWG.	MARKING	COLOR CODE
132-001	Obs.	132-010		MOTO./MA 113	1	MA 113	
132-002	Obs.	132-095		2N720	2	Q 101	
132-003	Obs.	132-014		2N657	1	Q 102	
132-004	Obs.	132-093	132-094	2N3391A	3	004 or A607	
132-005	Obs.	132-095		2N3053 (c)	1	RCA 35558	
132-007	Obs.	132-032		2N3638	8	007 or 2N3638	
132-008	Obs.	132-015 (a)		RCA40244	4A	40244 or TA2556	
132-009	Obs.	132-015 (a)		2N292	5	2N292	
132-010	Cur.			2N526	1	010 or 1C1554	
132-011	Obs.	132-093	132-094	Fairchild SE4010 (c)	6A	011 or S1239	Brn
132-014	Repair			Fairchild SE7001	1	014 or S1635	
132-015	Cur.		132-087	Fairchild SE3001	6A	015 or S1636	Grn
132-017	Obs.	132-095		2N720	2	017 or S1104	
132-018	Obs.	132-095		2N3403	7	018 or 2N3403	
132-019	Obs.	132-096		MOTO./SPS2801		2N3906	
132-020	Obs.	132-096		MOTO./SPS2800		2N3906A	
132-021	Cur.			2N3569	8	021 or S1644	Yel
132-022	Obs.	132-038 (b)		Fairchild SE7005	9	022 or S1643	
132-023	Cur.			2N3767 (c)	10	023	Brn
132-024	Cur.			2N3741 (c)	10	024	Red
132-025	Obs.	132-070		2N3716 (c)	11	025	Brn
132-026	Obs.	132-095		2N3417 (c) Vceo-Select	3	026	Red
132-027	Obs.	132-032		2N3638A	8	027	Red
132-028	Cur.			2N3738	10	028	Orn
132-029	Obs.	132-096		2N4249	6A	029 or 2N4249	Orn
132-030	Obs.	132-093	132-094	Fairchild SE4010 (c)	6A	030 or S1848	
132-031	Obs.	132-096		2N4250	6A	031 or 2N4250	Blu
132-032	Cur.			2N3645 (c)	8	032	Orn
132-033	Obs.	132-059		2N4297	10	2N4297	
132-036	Repair			SOL./SDT9202	11	036 or SDT9202	Red
132-038	Obs.	132-145		RCA40409 (c)	12	038	Brn
132-039	Obs.	132-146		RCA40410 (c)	12	039	Red
132-041	Obs.	132-094	132-095	SIEM./BC169C	13B	041 or BC169C	Red

TRANSISTOR REPLACEMENT & IDENTIFICATION DATA

PART NO.	STATUS	1st CHOICE	2nd CHOICE	COMMERCIAL TYPE	OUTLINE DWG.	MARKING	COLOR CODE
132-042	Cur.			2N3405 (c) Vceo-Select	7	042	
132-043	Obs.	132-070		2N3716	11	043	Yel
132-045	Obs.	132-064		3N140	15A	045	Brn
132-046	Obs.	132-072 (b)		BEN./B5031	14	046 or B5031	Blu
132-047	Obs.	132-064		3N141	15A	047	Red
132-048	Obs.	132-061 (a)		RCA40468	4B	048	Brn
132-049	Obs.	132-097 (a)		MOTO./2N5486	13A	049 or MPF107	Brn
132-050	Obs.	132-094	132-095	SIEM./BC169C Noise+Vceo- Select	13B	050 or BC169C	Grn
132-051	Obs.	132-095		SIEM./BC107B Noise+Vceo- Select	2	051 or BC107B	Orn
132-052	Obs.	132-090		2N5305	7	052 or 2N5305	Yel
132-054	Obs.	132-094	132-095	2N5210	13C	054 or 2N5210	Yel
132-055	Obs.			2N5089	13C	055 or 2N5089	Vio
132-056	Cur.	132-096		2N5087	13C	056 or 2N5087	Blu
132-057	Obs.	132-092 (a)	132-093	SIEM./BC168C	13B	057 or BC168C	Orn
132-058	Obs.	132-061		RCA40468A	15B	058 or 40468A	Orn
132-059	Repair			2N3739	10	059 or 2N3739	
132-060	Obs.	132-064		MOTO./MFE3007	15A	060 or MFE3007	Grn
132-061	Repair			MOTO./MFE3004	15B	061 or MFE3004	Yel
132-062	Obs.	132-093	132-094	2N5376	13D	062 or 2N5376	Gry
132-063	Obs.	132-093	132-094	SIEM./BC169B	13B	063 or BC169B	Red/Wht
132-064	Repair			MOTO./MFE3009-1	15A	064 or MFE3009-1	Blu
132-065	Cur.		GE246	2N4231 2N3054	10	065	
132-066	Cur.			2N3866	1	066 or 2N3866	
132-068	Cur.			2N5484	13A	068 or 2N5484	Brn/orn
132-069	Obs.	132-095		MOTO./2N5210 Vceo-Select	13C	069	Wht
132-070	Cur.			2N5303	11	070	Grn
132-072	Cur.			2N4922	32	072	
132-073	Obs.	132-097 (a)		2N5486 Idss-Select	13A	073 or 2N5486	Brn/Red
132-074	Cur.			SIEM./BC159B	38A	074 or BC159B	Blu

TRANSISTOR REPLACEMENT & IDENTIFICATION DATA

PART NO.	STATUS	1st CHOICE	2nd CHOICE	COMMERCIAL TYPE	OUTLINE DWG.	MARKING	COLOR CODE
132-075	Cur.			SIEM./BC147B	38A	075 or BC147B	Brn
132-076	Repair			2N5222	13E	076 or 2N5222	Sil
132-077	Cur.			SIEM./BC148C	38A	077 or BC148C	Red
132-078	Cur.			MOTO./MJE-341	32	078	Red
132-079	Cur.				32	079	Orn
132-080	Cur.				32	080	Yel
132-081	Cur.				32	081	Grn
132-082	Cur.			SIEM./BF194	38B	082 or BF194	Orn
132-085	Obs.	132-103	132-070	2N5303	11	085	Orn
132-086	Cur.			GI/MEM655	15B	086	Brn
132-087	Cur.			MOTO/MPS3563	13C	087 or MPS3563	Gld
132-088	Cur.			3N201	15A	088 or 3N201	Vio
132-089	Obs.	132-105		SIEM./BC169C Noise-Select	13B	041 or BC169C	Red/Gry
132-090	Cur.			MOTO./MPSA14 BV _{Ces} -Select	13C	090 or MPSA14	Pnk
132-091	Obs.	132-094		AMPX./A136	6A	091 or A136	Red
132-092	Cur.			SIEM./BC238C	44A	BC238C	Orn/Grn
132-093	Cur.			SIEM./BC239C	44A	BC239C	Red/Grn
132-094	Cur.			SIEM./BC414C	44A	BC414C	Yel/Grn
132-095	Cur.			GE/X32W6047	6A	095	Brn/Grn
132-096	Cur.			SIEM/BC416C	44A	BC416C	Blu/Grn
132-097	Cur.			T1/2N5245	45	097 or 2N5245	Brn/Yel
132-098	Cur.				2	098	Brn
132-100	Cur.			MOTO./MPS A66	13C	100 or MPS A66	Brn/Blu
132-102	Cur.			MOTO./MJE340	32	102 or MJE340	Blu
132-103	Obs.	132-128		2N5303	11	103	Vio/Blk
132-104	Cur			T1/2N5245 I _{dss} -Select	45	097 or 2N5245	Brn/Yel/ Red
132-105	Cur.			SIEM./BC239C Noise-Select	44A	BC239C	Red/Grn/ Gry
132-106	Cur.			2N6374 or RCA62952	10	106	
132-107	Cur.	132-073		2SK41E/2N5485/6 (2SK19)		K19	
132-108	Cur.	132-087		2SK1047C/MPS3563	13B	C1047C	
132-109	Cur.	132-087		2SC710D/MPS3563		C710	
132-110	Cur.	132-093		BF254/BC239C	38B		
132-111	Cur.			MPSA13	13C		

TRANSISTOR REPLACEMENT & IDENTIFICATION DATA

PART NO.	STATUS	1st CHOICE	2nd CHOICE	COMMERCIAL TYPE	OUTLINE DWG.	MARKING	COLOR CODE
132-112	Cur.	132-094		2SC828R	13B	C828	
132-113	Cur.			2N5210	50		
132-114	Cur.	132-096		2SA640K			
132-115	Cur.			2SA684R	51	A684	
132-117	Cur.			2N5087	49B		
132-118	Cur.			2SK34B		K34	
132-119	Cur.			2SC1124-2	52	C1124	
132-120	Cur.			2SA706	52	A706	
132-121	Cur.			2SD3236	11	2SD323L	
132-122	Cur.			2SC711E	13B	C711A	
132-123	Cur.			2SA641M	13B	A641M	
132-124	Cur.			2SC9450	13B	C945	
132-125	Cur.			2SC1384R	51	C1384	
132-126	Cur.			2SC1061C	53	C1061	
132-127	Cur.			2SD313	53	D313E	
132-128	Cur.			MOT. PL-4	11	132128	Black
132-129	Cur.			2N4036	1	132129	Orange
132-130	Cur.			2N2102	1	132130	Red
132-131	Cur.			MOT. PL321	10	132131	Blue
132-132	Cur.			MOT. PL322	10	132132	Green
132-133	Cur.				11	132133	Red
132-134	Cur.				11	132134	Brown
132-135	Cur.			MPS3639	13C		Red/Grn
132-136	Cur.			MPS-A42	13C		Vio
132-137	Cur.			MPS-U01A	52		Grn
132-138	Cur.			MPS-U51A	52		Red
132-139	Cur.			2N3055	11		
132-140	Cur.			MPS-A20	13C		
132-141	Cur.			MU4891	49I		Red/Yel
132-142	Cur.			2N5458	13A		
132-143	Cur.			MOT/MPSD05	13C	143 or MPSD05	Gray
132-144	Cur.			2N5978	58		
132-145	Cur.			RCA/2N5320-23	12	145	Green
132-146	Cur.			RCA/2N5322-23	12	146	Yellow
132-147	Cur.			MPS-A93	49A	147	White
132-148	Cur.			MPS-U57	52	148	Silver
132-149	Cur.			MPS-U07	52	149	Blue
132-150	Cur.			MPS-D55	49A	150	Orange
132-151	Cur.			MOT/PL1	11	151	Blue
132-152	Cur.			MOT/PL2	11	152	Vio/Red
132-153	Cur.			MOT/2N5681 FAIR/2N5320	1	153	Brown

REPLACEMENT

TRANSISTOR REPLACEMENT & IDENTIFICATION DATA

PART NO.	STATUS	1st CHOICE	2nd CHOICE	COMMERCIAL TYPE	OUTLINE DWG.	MARKING	COLOR CO
132-154	Cur.			MOT/2N5679 FAIR/2N5322	1	154	Red
132-155	Cur.			NC-LM114	1	155	Red
132-156				F0ST/30200711 25C1000			
132-157				F0ST/30200661 25C1222			
132-158	Cur.			F0ST/30000192 25A684	13B	2SA684	
132-159	Cur.			F0ST/30000312 2N5087	13C	2N5087	
132-160				SPR/BC414C	44B	160	Yellow

SELECTED TRANSISTOR REPLACEMENT & IDENTIFICATION DATA

PART NO.	STATUS	REPLACE WITH	OUTLINE DWG.	CASE	MARKING	COLOR CODE
132-501	Obs.	132-093	6A	T0-106	011 or S1239	Brn
132-502	Obs.	132-094	6A	T0-106	011 or S1239	Brn/Brn
132-503	Obs.	132-093	6A	T0-106	011 or S1239	Brn/Wht
132-504	Obs.	132-094	6A	T0-106	011 or S1239	Brn/Brn/Wht
132-515	Obs.	132-028	10	T0-66	028	Orn
132-516	Obs.	132-028	10	T0-66	028	Orn/Wht
132-517	Obs.	132-036	11	T0-3	036 or STD9202	Red/Orn
132-518	Obs.	132-036	11	T0-3	036 or STD9202	Red/Yel
132-519	Obs.	132-036	11	T0-3	036 or STD9202	Red/Grn
132-520	Obs.	132-036	11	T0-3	036 or STD9202	Red/Blu
132-521	Obs.	132-023	10	T0-66	023	Brn/Blk/Orn
132-522	Obs.	132-023	10	T0-66	023	Brn/Blk/Yel
132-523	Obs.	132-023	10	T0-66	023	Brn/Blk/Grn
132-524	Obs.	132-023	10	T0-66	023	Brn/Brn/Orn
132-525	Obs.	132-023	10	T0-66	023	Brn/Brn/Yel
132-526	Obs.	132-023	10	T0-66	023	Brn/Brn/Grn
132-527	Obs.	132-024	10	T0-66	024	Red/Blk/Orn
132-528	Obs.	132-024	10	T0-66	024	Red/Blk/Yel
132-529	Obs.	132-024	10	T0-66	024	Red/Blk/Grn
132-530	Obs.	132-024	10	T0-66	024	Red/Brn/Orn
132-531	Obs.	132-024	10	T0-66	024	Red/Brn/Yel
132-532	Obs.	132-024	10	T0-66	024	Red/Brn/Grn
132-533	Obs.	132-070	11	T0-3	025	Brn/Blk/Vio
132-534	Obs.	132-070	11	T0-3	025	Brn/Blk/Orn
132-535	Obs.	132-070	11	T0-3	025	Brn/Blk/Yel
132-536	Obs.	132-070	11	T0-3	025	Brn/Brn/Vio
132-537	Obs.	132-070	11	T0-3	025	Brn/Brn/Orn
132-538	Obs.	132-070	11	T0-3	025	Brn/Brn/Yel
132-539	Obs.	132-093	13B	T0-92	041 or BC169C	Red
132-540	Obs.	132-095	13B	T0-92	041 or BC169C	Red/Brn
132-541	Obs.	132-070	11	T0-3	043	Yel/Orn
132-542	Obs.	132-070	11	T0-3	043	Yel/Blu

INTEGRATED CIRCUIT REPLACEMENT & IDENTIFICATION DATA

PART NO.	STATUS	1st CHOICE	2nd CHOICE	COMMERCIAL TYPE	OUTLINE DWG.	MARKING	COLOR CODE
133-001	Repair			RCA/CA3012	16	001 or CA3012	
133-002	Cur.			RCA/CA3042	17 or 33	002 or CA3042	Brn
133-003	Cur.			RCA/CA3028B NS/LM3028	31	003 or CA3028B or LM3028	
133-004	Cur.			MOTO./MC1303	33	004 or MC1303	Red
133-005	Cur	132-003 NS/LM3028		RCA/CA3053 NS/LM3053	31	005 or CA3053 or LM3053	
133-006	Cur			NS/LM371	16	006 or LM371	
133-007	Cur			MOTO./MC1437P	33	007 or MC1437P	Vio
133-008	Cur			MOTO./MC7479P	33	008 or MC7479P	Sil
133-009	Cur.			LA1221			
133-010	Cur.			T1SN76502N			
133-011	Cur.			MC7400P	33		
133-012	Cur.			MC7401P	33		
133-013	Cur.			MC7402P	33		
133-014	Cur.			MC7410P	33		
133-015	Cur.			T1SN7412P MOT MC3007P	33		
133-016	Cur.			MC7472P	33		
133-017	Cur.			MC7475P	33		
133-018	Cur.			MC7490P	33		
133-019	Cur.			MC7493P	33		
133-020	Cur.			MC74121P	33		
133-021	Cur.			MC1455P1	57		
133-022	Cur.			MC839P	33		
133-023	Cur.			MC1809P	33		
133-024	Cur.			MC1812P	33		
133-025	Cur.			MC10131L	55		
133-026	Cur.			NAT/DM880N BECKMAN DD700	55		
133-027	Cur.			MC1711P	33		
133-028	Cur.			MC1458P1	57		
133-029	Cur.			CA3089E	55		
133-030	Cur.			MLM309K	11		

INTEGRATED CIRCUIT REPLACEMENT & IDENTIFICATION DATA

PART NO.	STATUS	1st CHOICE	2nd CHOICE	COMMERCIAL TYPE	OUTLINE DWG.	MARKING	COLOR CODE
133-031	Cur.			FAIRCHILD/ μA703C	56		
133-032	Cur.			MC1310P	33	1310P	
133-033	Cur.			TOSH. TA7061AP	54		
133-034	Cur.			FAIRCHILD/ μA753C	57		
133-035	Cur.			MC1416	33		
133-036	Cur.			MC1355P	33		
133-037	Cur.			MC/MLM301A P1	57		
133-038							
133-039							
133-040	Cur.			MPQ6100A	33		
133-041	Cur.			SELECTED MC1437P	33	041	

TEST DATA

DIODE TEST DATA

PART NO.	MATERIAL	Diodes - Rectifiers			Zeners			REMARKS
		PRV (volts)	I _F (mA)	I _R (μ A)	V _Z (volts)	TOL. (%)	Pd (mW)	
070-001	Si							Varactor Diode
070-002	Si				6.8			
070-003	Ge	45	10	18				1N541/542
070-004	Se							4 Plate Bridge
070-005	Se	380	65					
070-006	Si	600	500					
070-007	Si	500	500					1N2863
070-008	Si	50	1.6A					1N1217
070-009	Si	400	400					1N647
070-010	Si	400	150					1N3756
070-011	Si				10	10	250	1N714
070-012	Si				75	20	400	1N982
070-013	Se		300					2 Plate Doubler
070-014	Si	100	1A					
070-015	Si	400	750					
070-016	Si	600	750					
070-017	Si	800	750					
070-018	Se	1200	10					
070-019	Se							
070-020	Si							Varactor Diode
070-021	Si				15	10	1W	1N4744
070-022	Si	75	20	5				1N914A
070-023	Si				6.8	5	400	1N754A
070-024	Si				10	5	400	1N758A
070-025	Si				75	5	400	1N982B
070-026	Se	3000	4					
070-027	Si	100	3A					1N4720
070-028	Si	50	1A					1N4001
070-029	Si				27	20	1.5W	1N3799
070-030	Si	50	1.5A					1N4816
070-031	Si	400	1.5A					1N4820
070-032	Si	600	1.5A					1N4822
070-033	Si	800	1.5A					1N5053
070-035	Si				5.6	10		
070-036	Si	700	3A					WH398P
070-037	Si				180	5	1W	1N3050B
070-038	Si	100	18A					Anode Case 1N3492R
070-039	Si	100	18A					Cathode Case 1N3492
070-040	Si				1.46V	2	(@25mA)	Stabistor
070-041	Si	100	3A					WH398B
070-042	Si				16	10	400	1N966A

TEST DATA

DIODE TEST DATA

PART NO.	MATERIAL	Diodes - Rectifiers			Zeners		Pd (mW)	REMARKS
		PRV (volts)	I _f (mA)	I _r (μ A)	V _Z (volts)	TOL. (%)		
070-043	Si	800	3A				1N4724	
070-044	Si	400	2A				Full Wave Bridge	
070-045	Si	50	2A				Full Wave Bridge	
070-046	Si				1.34	2 (@ 10mA)	Stabistor	
070-047	Si	75	10	25N			1N4148	
070-048	Si				16	5	400	
070-049	Si				24	5	1W	
070-050	Si	100	27A				MDA990-2	
070-051	Si	50	4A				Full Wave Bridge	
070-052	Ge	45	2	18			070-003 Selected For: V _f < .5V	
070-053	Si				180	5	3W	
070-054	Si				51	5	1W	
070-055	Si	35					Pin Diode	
070-056	GaAsP						Light Emitting Diode (Led)	
070-057	Si				4.7	5	400	
070-058	Si	2000	250	100				
070-059	Si	800	1.0A	30				
070-060	Si				200	5	1W	
070-061	Si				15	10	1W	
070-062	Si				120	5	400	
070-063	Si				30	5	1W	
070-064	Si				20	10	400	
070-065	Si				24	5	1W	
070-066	Si				9	5	1W	
070-067	Si						Varactor	
070-068	Si				16	5	1W	
070-069	Ge	60	5	30				
070-070	Si							
070-071	Si							
070-072	Si							
070-073								
070-074	Si				16	5		
070-075	Si				7.5	5	400	
070-076	Se	200	25A				Bridge Rectifier	
070-077	Si				15	5	2W	
070-078	Si				12	5	1W	
070-079	Se	200	25A				Bridge Rectifier	
070-080	Si	C _t 19V = 6.1 \pm 0.1pF						Varactor
070-081	Si	50	2pF	0.2			Schottky	

TEST DATA

DIODE TEST DATA

PART NO.	MATERIAL	Diodes - Rectifiers			Zeners		Pd (mW)	REMARKS
		PRV (volts)	I_f (mA)	I_r (μ A)	V_z (volts)	TOL. (%)		
070-082	Si				39	5	400	
070-083	Si				29			RD29A
070-084	Si	C = 30V = 29 \pm 3pF						Varactor
070-085	Si				6.2	5	500	
070-086	Si	35	$1\text{pF}/.6\Omega$	$.1\mu\text{A}$				Pin Diode
070-087	Si	2000V	250mA	100 μ A				H.V. Rectifier
070-088	Si				5	10	300	
070-089	Si				16	5	500	

THYRISTOR & TRIGGER TEST DATA

PART NO.	PRV (volts)	I _f (amps)	V _{gate} (volts)	I _{gate} (mA)	REMARKS
131-001	100	6	3	50	Triac SC41F
131-002		175mA	7.5 - 9.0		Bilateral Switch 2N4992
131-003	50	8	2.5	50	Triac MAC 6-2
131-004		175mA	6 - 10		Bilateral Switch 2N4991
131-005	50	8	2.0	50	Triac MAC 11-2
131-006					
131-007					

TEST DATA

TRANSISTOR TEST DATA

PART NO.	MATERIAL	POLARITY	V _{ceo} or V _{ds} (volts)	H _{fe} or Y _{fs} (min)	H _{fe} or Y _{fs} (max)	@ I _c or V _{gs}	I _{dss} (mA)	P _d (mW)	NF (dB)	REMARKS
132-001	Ge	PNP	15	50		1				
132-002	Si	NPN	80	45	180	2				2N720
132-003	Si	NPN	150	25		20				
132-004	Si	NPN	25	400	800	2			low	
132-005	Si	NPN	40	50	250	150				
132-007	Si	PNP	25	20		10				2N3638
132-008	Si	NPN	45	27	170	1				40244
132-009	Ge	NPN	15	8	51	1				
132-010	Ge	PNP	30	53	90	20				
132-011	Si	NPN	25	200	680	50μA			low	
132-014	Si	NPN	150	30		30				
132-015	Si	NPN	12	20		8				SE3001
132-017	Si	NPN	80	45	180	2				2N720
132-018	Si	NPN	25	180	540	2		900 @ T _c =25°C		2N3403
132-021	Si	NPN	40	90		30				
132-022	Si	NPN	100	50		50				
132-023	Si	NPN	90	25		150		14W @ T _c =100°C		
132-024	Si	PNP	90	25		150		14W @ T _c =100°C		
132-025	Si	NPN	80	25		3A		150W @ T _c =25°C		
132-026	Si	NPN	60	180	540	2				
132-027	Si	PNP	25	80		1				2N3638A
132-028	Si	NPN	120	65		50				
132-029	Si	PNP	60	100	300	100μA				2N4249
132-030	Si	NPN	25	300	680	50μA			low	
132-031	Si	PNP	40	250	700	100μA			low	2N4250
132-032	Si	PNP	60	50		100				
132-033	Si	NPN	250	75	300	50		20W @ T _c =25°C		2N4297
132-036	Si	NPN	90 (V _{cer})	20		4A		117W @ T _c =25°C		SDT9202
132-038	Si	NPN	80	40		100		3W @ T _a =25°C		
132-039	Si	PNP	80	40		100		3W @ T _a =25°C		
132-041	Si	NPN	20	450	900	2			low	BC169C
132-042	Si	NPN	60	180	540	2		560 @ T _a =25°C		
132-043	Si	NPN	90 (V _{cer})	20	80	5A		100W @ T _c =75°C		
132-045	Si	N	20 (VDS)	10 mmho						Dual Gate MOS-FET 3N140

TRANSISTOR TEST DATA

PART NO.	MATERIAL	POLARITY	V_{ce0} or V_{ds} (volts)	H_{fe} or Y_{fs} (min)	H_{fe} or Y_{fs} (max)	@ I_c or V_{gs}	I_{dss} (mA)	P_d (mW)	NF (dB)	REMARKS
132-046	Si	NPN	35	60	120	500		14W @ $T_c=100^\circ C$		B-5031
132-047	Si	N	20 (VDS)	10 mmho			5-30			Dual Gate MOS-FET 3N141
132-048	Si	N	20 (VDS)	7.5 mmho			25 Max.			MOS-FET 40468
132-049	Si	N	25 (VDS)	4 mmho	8 mmho	$V_{gs}=0$	8-20	310 @ $T_c=25^\circ C$	2 @ 100MHZ	J-FET 2N5486
132-050	Si	NPN	60	450	900	2			2.5	
132-051	Si	NPN	60	240	500	2			4	
132-052	Si	NPN	25	2000	20,000	2				Darlington 2N5305
132-054	Si	NPN	50	200	600	100 μ A			3	2N5210
132-055	Si	NPN	25	400	1200	100 μ A			2	2N5089
132-056	Si	PNP	50	250	800	100 μ A			2	2N5087
132-057	Si	NPN	20	450	900	2				BC168C
132-058	Si	N	20 (VDS)	7.5 mmho		5	25 Max.	375 @ $T_a=25^\circ C$		MOS-FET 40468A
132-059	Si	NPN	300	40	200	100		20W @ $T_c=25^\circ C$		2N3739
132-060	Si	N	25 (VDS)	10 mmho			5-20	300 @ $T_a=25^\circ C$	4 @ 200MHZ	Dual Gate MOS-FET MFE 3007
132-061	Si	N	20 (VDS)	2 mmho		2	2-10	200 @ $T_c=25^\circ C$	4.5 @ 200MHZ	MOS-FET MFE 3004
132-062	Si	NPN	30	100	500	10 μ A		360 @ $T_c=25^\circ C$	2	2N5376
132-063	Si	NPN	20	240	500	2		220	4	BC169B
132-064	Si	N	25 (VDS)	6.3 mmho			5-30	300 @ $T_a=25^\circ C$		Dual Gate MOS-FET MFE 3009-1
132-065	Si	NPN	40	50		500		20W @ $T_c=25^\circ C$		
132-066	Si	NPN	30	10	200	50		5W @ $T_c=25^\circ$		2N3866
132-068	Si	N	25 (VDS)	3 mmho	6 mmho		1-5	310 @ $T_c=25^\circ C$	3 @ 100MHZ	J-FET 2N5484
132-069	Si	NPN	60	200	600	100 μ A		310 @ $T_a=25^\circ C$	3	
132-070	Si	NPN	80	30	90	5A		100W @ $T_c=75^\circ C$		
132-072	Si	NPN	60	40		0.2A		30W @ $T_c=25^\circ C$		
132-073	Si	N	25 (VDS)	4 mmho	8 mmho	$V_{gs}=0$	12-18	310 @ $T_c=25^\circ C$	2 @ 100MHZ	J-FET
132-074	Si	PNP	20	240	500	2		220 @ $T_a=25^\circ C$		BC159B
132-075	Si	NPN	45	240	500	2		220 @ $T_a=25^\circ C$		BC147B
132-076	Si	NPN	15	20	150	4		310 @ $T_a=25^\circ C$		2N5222

TEST DATA

TRANSISTOR TEST DATA

PART NO.	MATERIAL	POLARITY	V_{ce0} or V_{ds} (volts)	H_{fe} or Y_{fs} (min)	H_{fe} or Y_{fs} (max)	I_c or V_{gs} (mA.)	I_{dss} (mA)	P_d (mW)	NF (dB)	REMARKS	
132-077	Si	NPN	30	450	900	2		220 @ $T_a=25^\circ C$	BC148C		
132-078	Si	NPN	150	20		20		1W @ $T_a=25^\circ C$			
132-079	Si	PNP	90	40		150		30W @ $T_c=25^\circ C$			
132-080	Si	NPN	90	40		150		30W @ $T_c=25^\circ C$			
132-081	Si	NPN	90	60		50		30W @ $T_c=25^\circ C$			
132-082	Si	NPN	20	115 typ		1		220 @ $T_a=25^\circ C$	1.2 @ 1 MHz	BF194	
132-085	Si	NPN	80	10		5A		200W $25^\circ C$			
132-086	Si	N	20 (VDS)	6 mmho	10 mmho	5	1-20	225mW $T_a=25^\circ C$	MOS-FET Gen. Inst. MEM 655		
132-087	Si	NPN	12	20	200	8		310mW $T_a=25^\circ C$	Motorola MPS-3563		
132-088	Si	N	24	8 mmho	12 mmho		5-15		Dual Gate MOS-FET 3N201		
132-089	Si	NPN	20	450	900	2			<1.5 μV	SIEM./BC169C Noise Select	
132-090	Si	NPN	40	10K		10		500	2	MOTO/ MPS A14	
132-091	Si	NPN	50	400	800	2		300	1.5	AMPX/A136	
132-092	Si	NPN	20	380	800	2		300	10	SIEM./ BC238C	
132-093	Si	NPN	20	380	800	2		300	4	SIEM./ BC239C	
132-094	Si	NPN	45	380	800	2		300	3	SIEM./ BC414C	
132-095	Si	NPN	60	350		2		400	2	G.E./ X32W6047	
132-096	Si	PNP	45	380	800	2		300	2	SIEM./ BC416C	
132-097	Si	N	30	4.5 mmho	7.5 mmho		5-15		2	T.I./ 2N5245	
132-098	Ge	PNP	$(V_{bes} = 0.266 \text{ to } 0.294 \text{ V @ } 30\text{mA})$								
132-100	Si	PNP	30	75K		10		500	2	MOTO./ MPS A66 Darlington	
132-102	Si	NPN	220	20		1		1W		MOTO./ MJE 340	
132-103	Si	NPN	100	40		7.5A		200W			
132-105	Si	NPN	20	450	900	2		300	<1.5 μV	SIEM./ BC239C Noise Select	
132-106	Si	NPN	40		80	0.5A				2N6374/ RCA62952	
132-107	Si	N	18	7.5mmho		18		200		2SK19/ 2N5485/6	
132-108	Si	NPN	12	20		8		310mW		2SK1047C/ MPS3563	
132-109	Si									2SK7100	

TEST DATA

TRANSISTOR TEST DATA

PART NO.	MATERIAL	POLARITY	V_{ce0} or V_{ds} (volts)	H_{fe} or Y_{fs} (min)	H_{fe} or Y_{fs} (max)	I_c or V_{gs} (mA.)	I_{dss} (mA)	P_d (mW)	NF (dB)	REMARKS
132-110	Si	NPN	20	115		1				
132-111	Si	NPN	30	5K		10				Darlington
132-112	Si	NPN	30	65	700	2		400		2SC828R
132-113	Si	NPN	20	75		10		1200		2N5201
132-114	Si	PNP	50	175		150		400		2SA640K
132-115	Si	RNP	50	60	340	1A		7W		2SA684R
132-117	Si	PNP	50	250		10		310		2N5087
132-118	Si	N								J. FET
132-119	Si	NPN	250	75		50		20W		2SC1124
132-120	Si	PNP								2SA706
132-121	Si	NPN								2SD323L
132-122	Si	NPN	40	100		10		300		2SC711E
132-123	Si	PNP	50	175		150		400		2SA641M
132-124	Si	NPN								2SC9450
132-125	Si	NPN	50	150		10		400		2SC1384R/2SC1222
132-126	Si	NPN	70	70		1		50W		2SC1061
132-127	Si	NPN	70	70		1		50W		2SD313
132-128	Si	NPN	100	25		7.5A		200W		MOTO PL4
132-129	Si	PNP	70	80		100		5W		2N4036
132-130	Si	NPN	70	80		100		5W		2N2102
132-131	Si	PNP	100	60		250		20W		MOTO PL321
132-132	Si	NPN	100	60		250		20W		MOTO PL322
132-133	Si	PNP	100	30		7.5A		200W		
132-134	Si	PNP	100	30		7.5A		200W		
132-135	Si	PNP	6	5		10		500		MPS3639
132-136	Si	NPN	300	40		30		1.5W		MPS A42
132-137	Si	NPN	40	60		100		1W		MPSU01A
132-138	Si	PNP	40	55		10		1W		MPSU51A
132-139	Si	NPN	60	20	70	4A		115W		2N3055
132-140	Si	NPN	40	40	400	5		300		MPSA20
132-141	Si	UNIJ						300		MU4891
132-142	Si	N	25				6	310		2N5458
132-143	Si	NPN	25	50		50		350		MPSD05
132-144	Si	NPN	60	20	120	2.5A DC				2N5978
132-145	Si	NPN	100	40		100mA				2N5320-23
132-146	Si	PNP	100	40		100mA				2N5322-23
132-147	Si	PNP	200	25		1mA		600		MPS A93
132-148	Si	PNP	100	60		50		1W		MPS U57
132-149	Si	NPN	100	60		50		1W		MPS U07
132-150	Si	PNP	25	50		50		350		MPS D55
132-151	Si	PNP	100	50		750		100W		MOT PL 1

TEST DATA

TRANSISTOR TEST DATA

PART NO.	MATERIAL	POLARITY	V _{ceo} or V _{ds} (volts)	H _{fe} or Y _{fs} (min)	H _{fe} or Y _{fs} (max)	@ I _c or V _{gs} (mA)	I _{dss} (mA)	P _d (dB)	NF	REMARKS
132-152	Si	NPN	100	50		750		100W		MOT PL 2
132-153	Si	NPN	90	40		100				2N5681
132-154	Si	PNP	90	40		100				2N5679
132-155	Si	NPN	30	200		50μA				LM114
132-156	Si	NPN								2SC1000
132-157	Si	NPN								2SC1222
132-158	Si	PNP	50	50		1		750		2SA684
132-159	Si	PNP	50	250		1		310	1	2N5087
132-160	Si	NPN	45	380	800	2		300	3	SPR/BC414C

TEST DATA

INTEGRATED CIRCUIT TEST DATA

PART NO.	SUPPLY VOLTS	GAIN	P _t	MAX F & DELAY	REMARKS
133-001	13	61 dB @ 10.7 MHz	300 mW	20 MHz	CA 3012
133-002	11.2	67 dB @ 4.7 MHz 30 dB @ 1 kHz	950 mW	20 MHz	CA 3042
133-003	±12	42.5 dB @ 1 kHz	450 mW @ T _a =85°C	120 MHz	CA 3028B
133-004	±15	Dual 60 dB @1 kHz	415 mW	50 kHz	MC 1303L
133-005	±12	35 dB @ 10.7 MHz	450 mW	120 MHz	CA 3053
133-006	24	27.5 dB @ 100 MHz	230 mW	200 MHz	LM 371
133-007	±15	90 dB @ 1 kHz	750	1 MHz	MC 1437P
133-008	+5	Dual type D flip-flop	84 mW	30 MHz	MC 7479P
133-009	16	28dB @ 100 MHz	96 mW		FM-IF AMP
133-010					LOG AMP
133-011	5.0		40 mW	10ns	MTTL
133-012	5.0		40 mW	25ns	MTTL
133-013	5.0		40 mW	10ns	MTTL
133-014	5.0		30 mW	10ns	MTTL
133-015	5.0		66 mW	8ns	MTTL III
133-016	5.0		40 mW	20 MHz	MTTL
133-017	5.0		160 mW	30ns	MTTL
133-018	5.0		160 mW	10 MHz	MTTL
133-019	5.0		160 mW	10 MHz	MTTL
133-020	5.0		90 mW	80ns	
133-021	5.0		15 mW	100ns	
133-022	5.0		150 mW	48 MHz	MDTL
133-023	5.0		130 mW	30ns	MDTL
133-024	5.0		130 mW	40ns	MDTL
133-025	5.0		235 mW	160 MHz	MECL
133-026	5, 200		600 mW	10μs	
133-027	+12 -5	64dB	130 mW	40ns	
133-028	±15	100dB	70 mW	1MHz	Op Amp.
133-029					FM-IF-DET.
133-030	5/35				Volt. Reg.
133-031					FM-IF-Amp.
133-032					Stereo Demod.
133-033					FM-IF-Amp.
133-034		50dB @ 10.7MHz	310 mW		FM Gain Block
133-035	16	300Ω on Res.	.1 mW		Switch
133-036		60dB @ 10.7MHz	625 mW		FM-IF-Amp
133-037	±15	84dB	60 mW	5MHz	
133-038					
133-039					
133-040	40		1W	125MHz	
133-041	±15	90dB @ 1KHz	750	1MHz	SEL/MC1437P

① TO-5 & TO-39

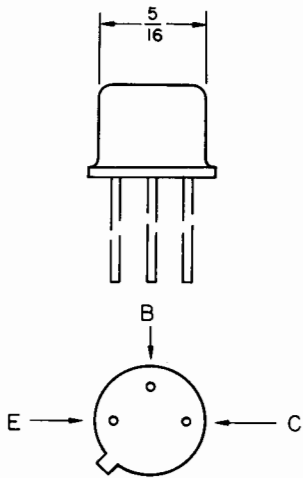

② TO-18

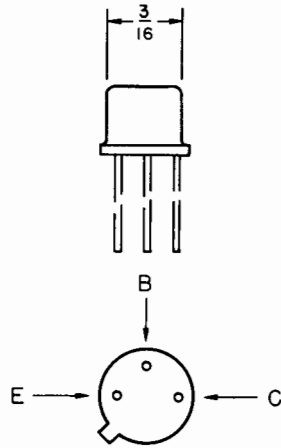

③ TO-98

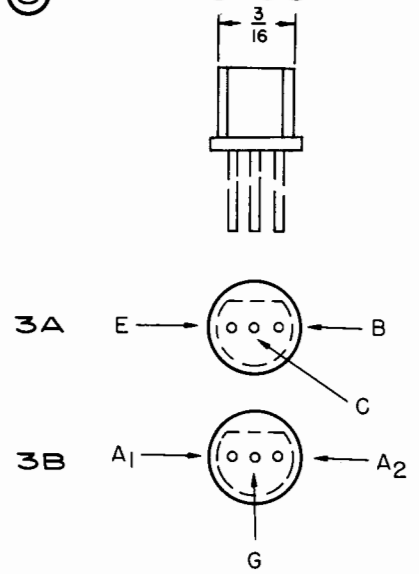

④ TO-104

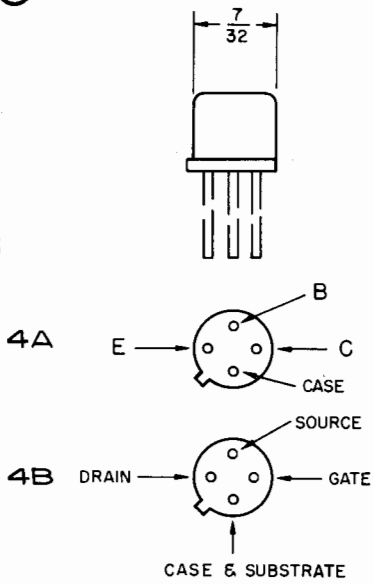

⑤

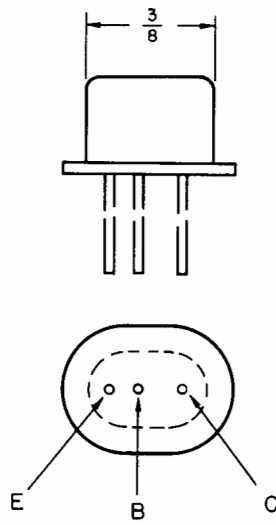

⑥ TO-106

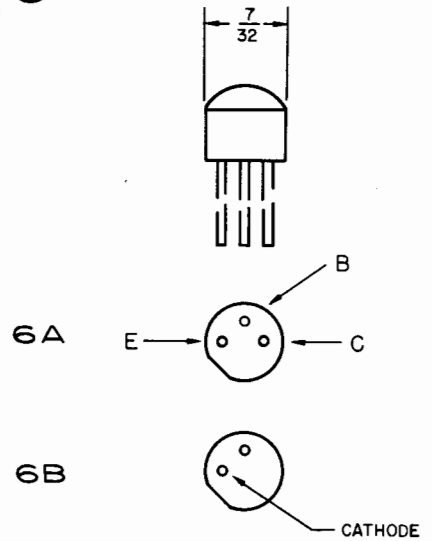

⑦ TO-98/w FLAG

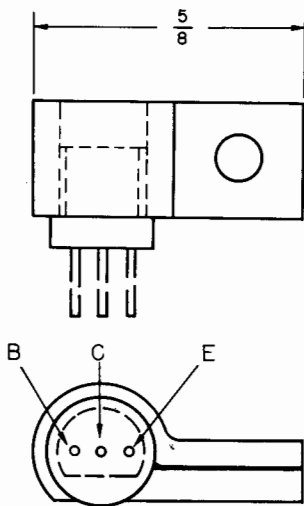

⑧ TO-105

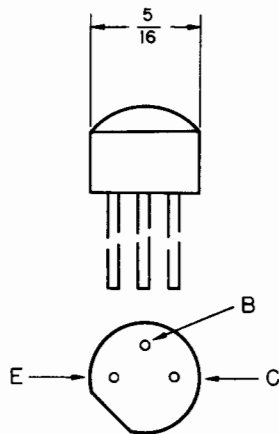

⑨ TO-5/w FLANGE

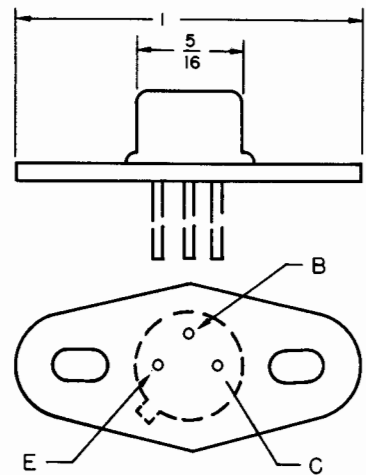

10

TO-66

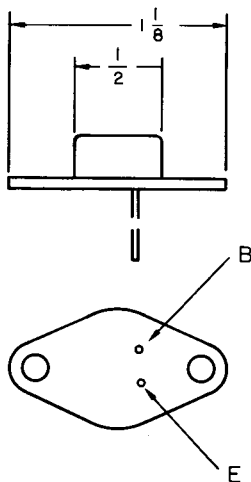

11

TO-3

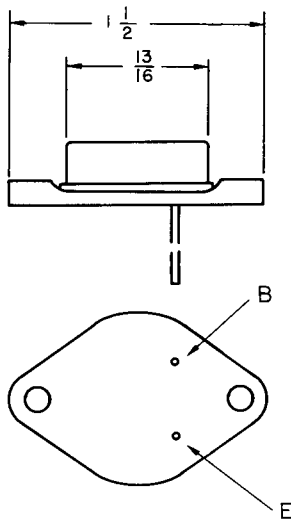

12

TO-5/W HEATSINK

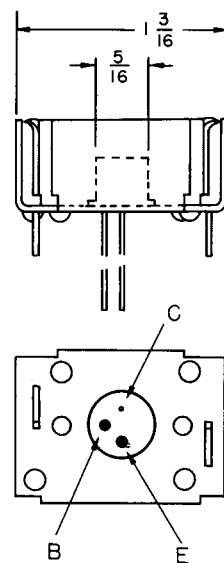

13

TO-92

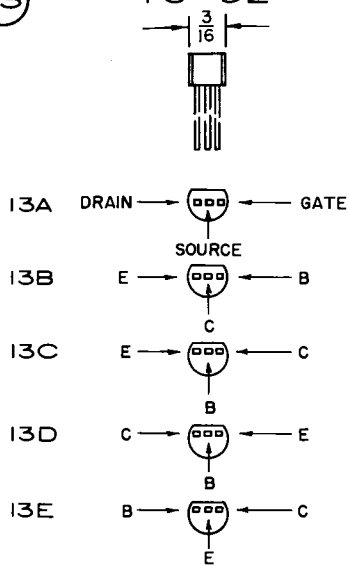

14

SPECIAL TO-66

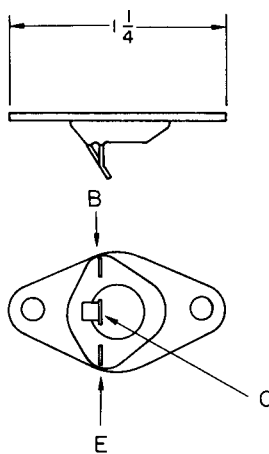

15

TO-72

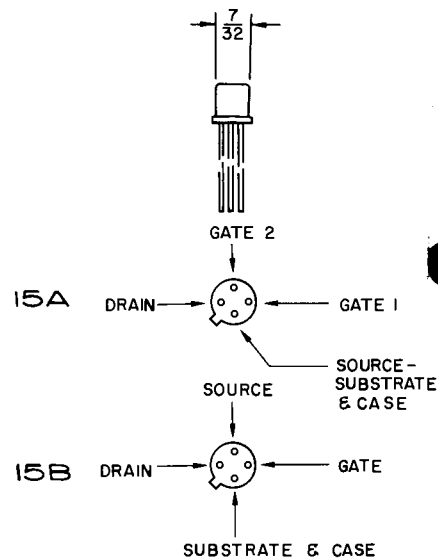

16

TO-5 (10 LEAD)

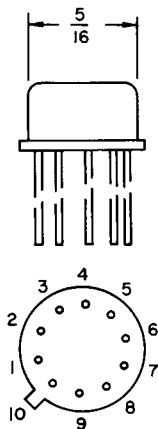

17

TO-116

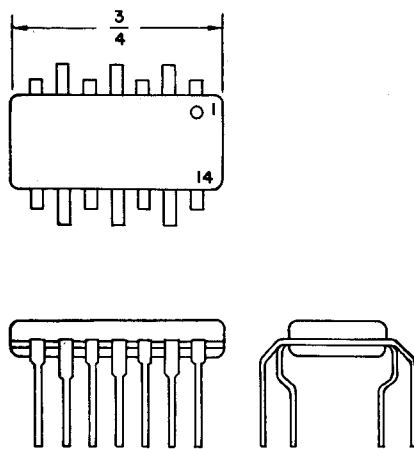

18

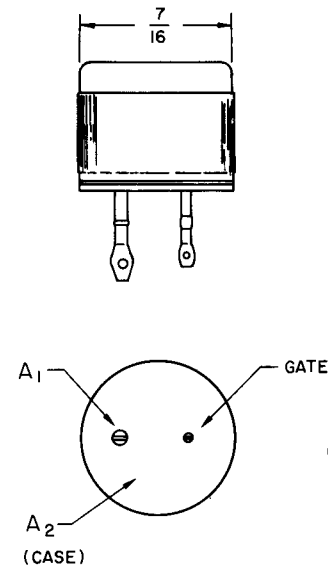

19

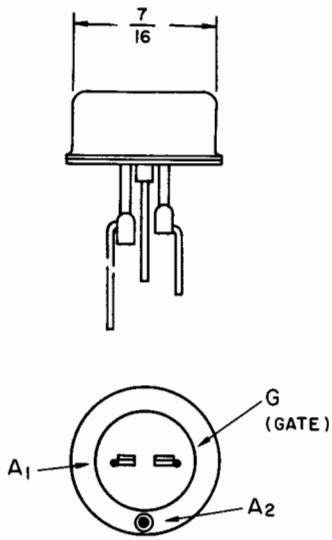

20

DO-7 (GLASS)

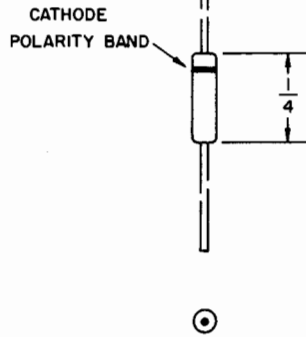

21

DO-1

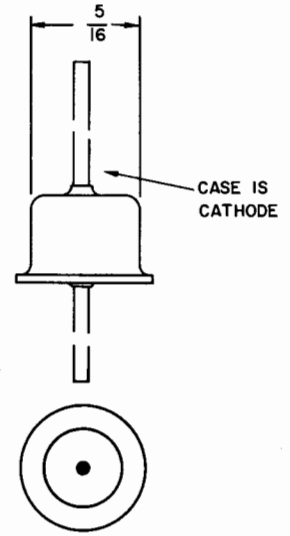

22

DO-21

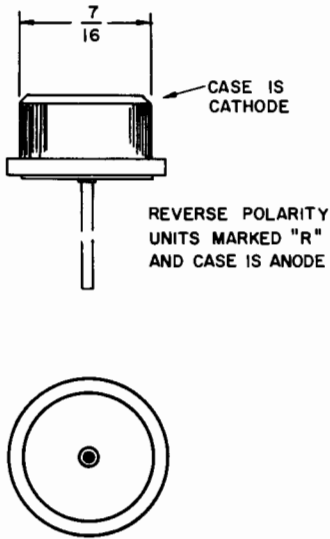

23

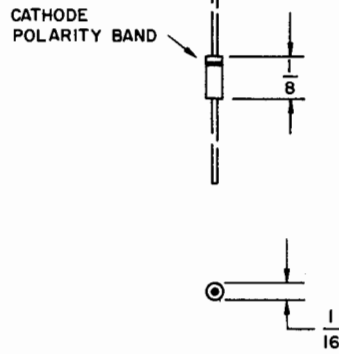

24

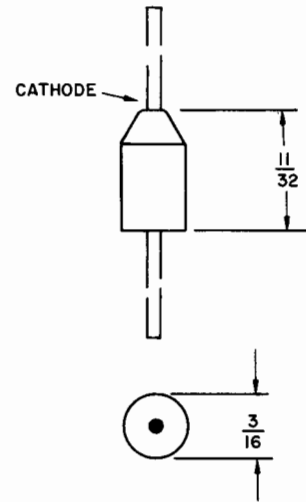

25

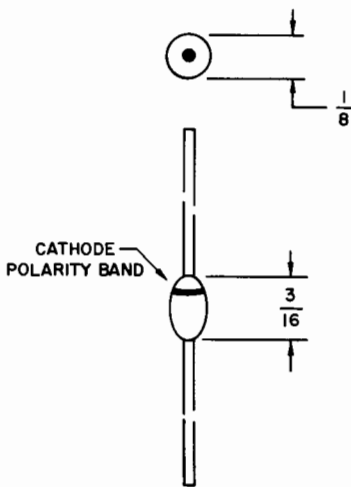

26

DO-41

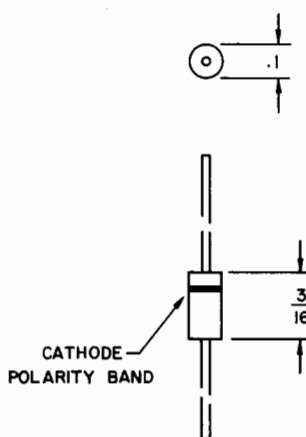

27

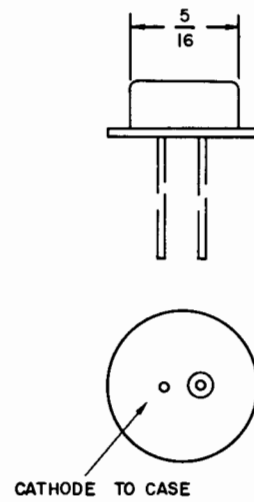

28

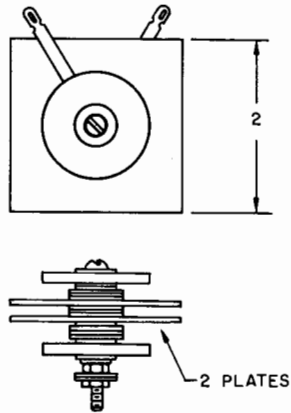

29

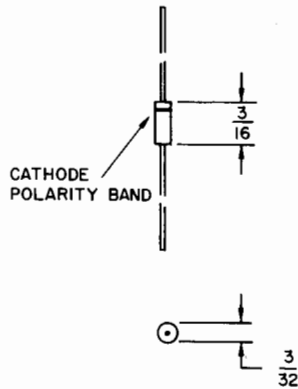

30

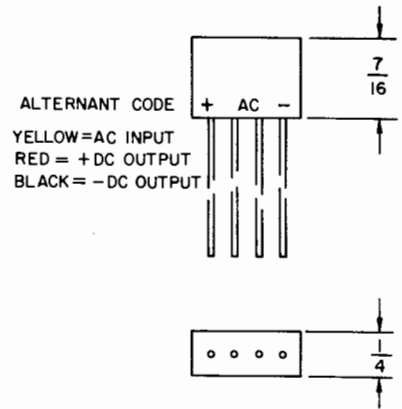

31

TO-5 (8 LEAD)

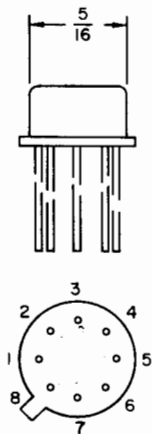

32

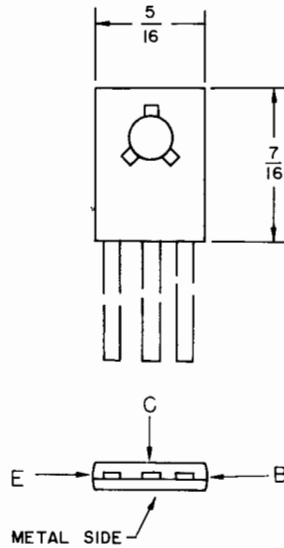

33

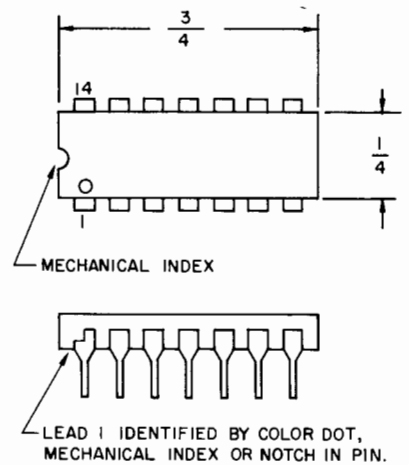

34

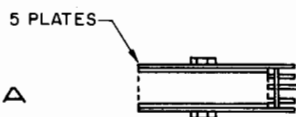
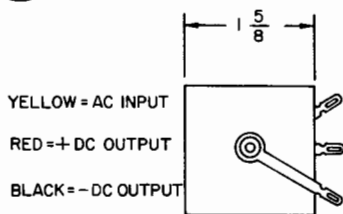

34A

34B

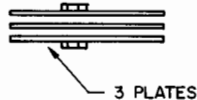

35

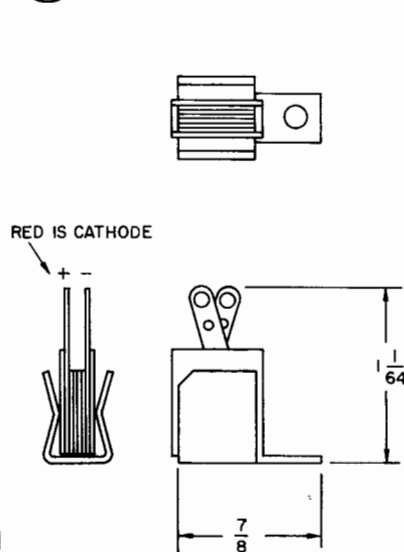

36

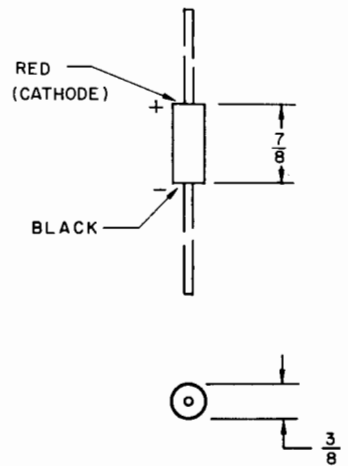

37

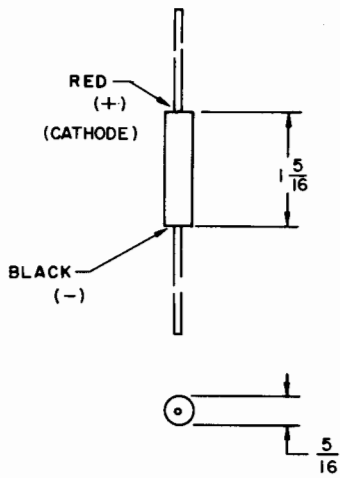

38

SOT-25

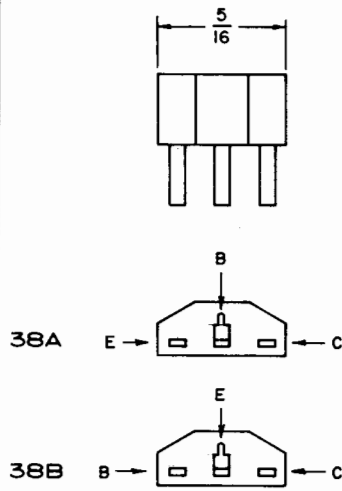

39

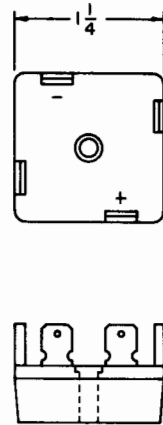

40

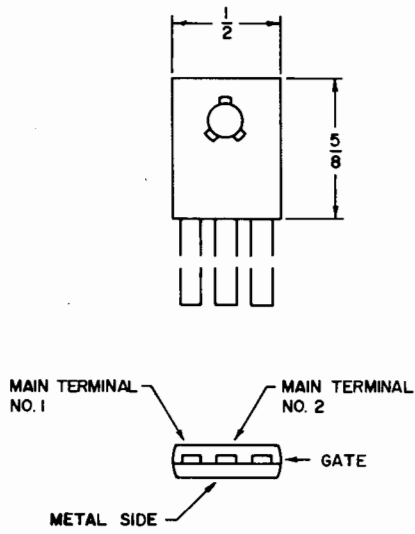

41

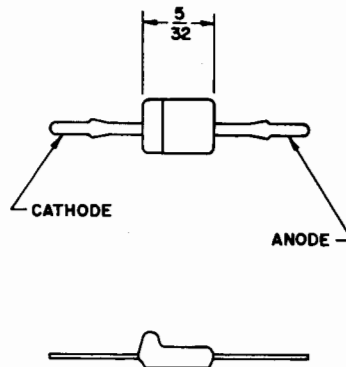

42

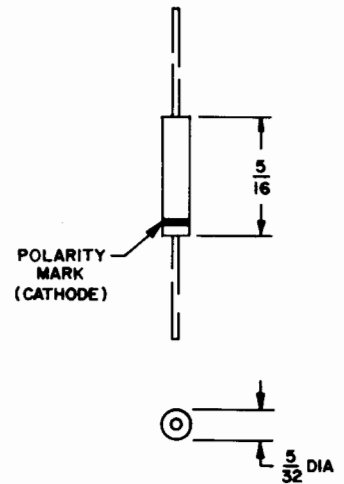

43

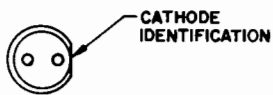
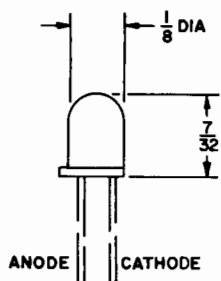

44

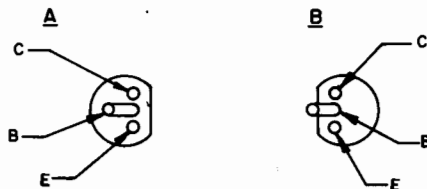
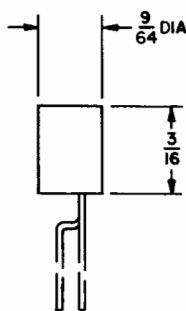

45

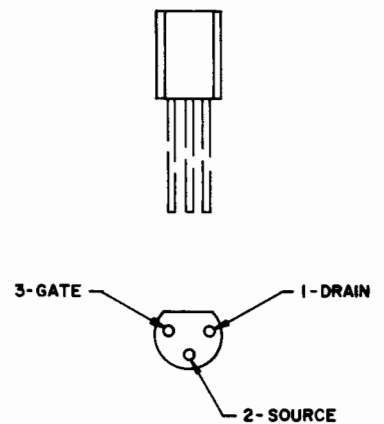

46

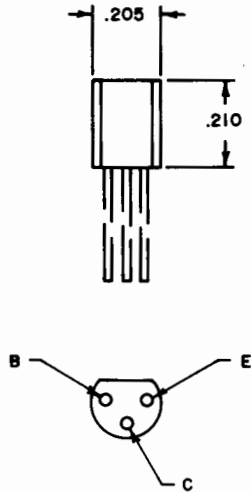

47

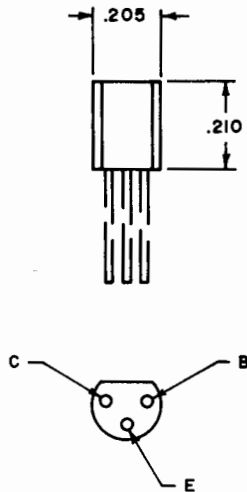

48



48A 1. ANODE
2. CATHODE

48B 1. CATHODE
2. ANODE

48C 1. MAIN TERM. 1
2. MAIN TERM. 2

49

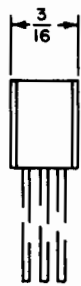

- A 1. EMITTER
2. BASE
3. COLLECTOR
- B 1. BASE
2. EMITTER
3. COLLECTOR
- C 1. ANODE
2. ANODE
3. CATHODE
- D 1. CATHODE
2. CATHODE
3. ANODE
- E 1. DRAIN
2. SOURCE
3. GATE
- F 1. GATE
2. SOURCE & SUBSTRATE
3. DRAIN
- G 1. SOURCE
2. DRAIN
3. GATE
- H 1. DRAIN
2. GATE
3. SOURCE & SUBSTRATE
- I 1. BASE 1
2. EMITTER
3. BASE 2
- J 1. CATHODE
2. GATE
3. ANODE
- K 1. ANODE
2. CATHODE & ANODE
3. CATHODE
- L 1. ANODE 1
2. GATE
3. ANODE 2
- M 1. ANODE 1
2. GATE
3. CATHODE 2
- N 1. EMITTER
2. COLLECTOR
3. BASE
- O 1. ANODE 1
2. GATE
3. ANODE 2
- P 1. ANODE
2. GATE
3. CATHODE
- Q 1. COLLECTOR
2. BASE
3. EMITTER



50

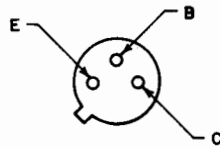

51

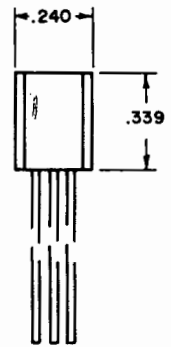

52

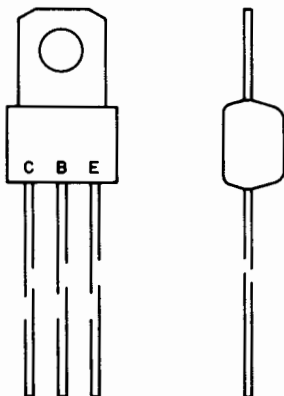

53

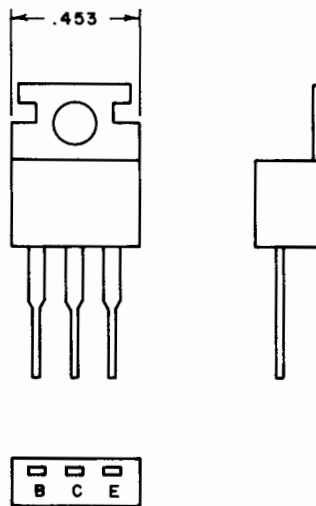

54

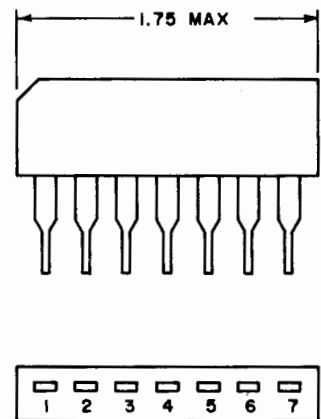

55

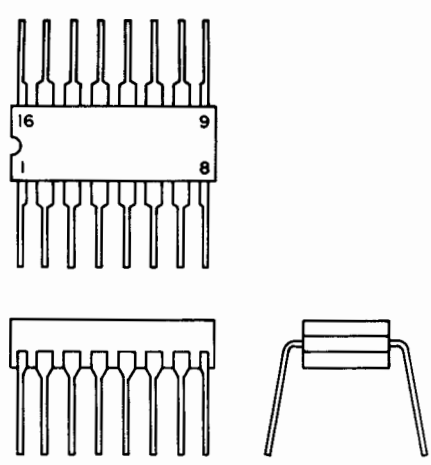

56

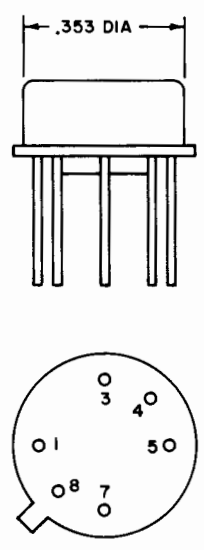

57

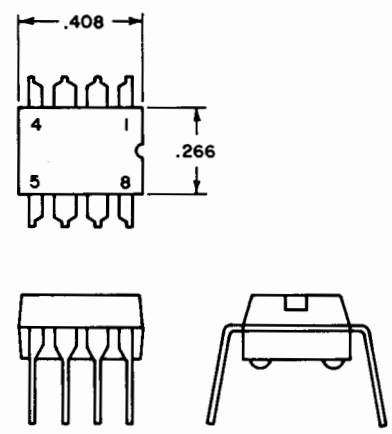

58

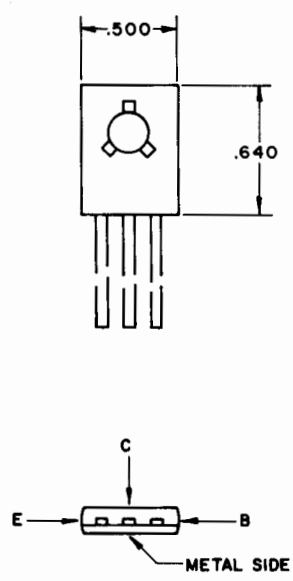

59

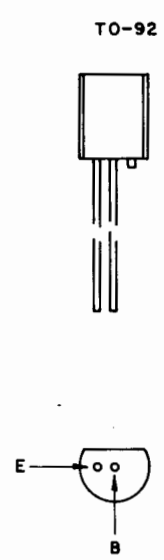

60

61

62

63